



BuzziPlant

Product Specification Sheet

This document contains technical information about the BuzziPlant



www.buzzi.space

Do you need privacy, quiet or protection?

Do you need privacy, quiet or protection? The BuzziPlants are the first room dividers that combine no less than three factors: sound insulation, design and a surface you can stick pins onto. Thanks to the striking shape and colour of the three available plants, you can make a statement at home or at the office. Put your BuzziPlant in direct sunlight – it deserves to be seen!

Design by Anthony Duffeleer

General

 Doldi | Mobi | Surf

Core: honeycomb cardboard

Filling: foam CME35H + fabric + zipper

 Baseplate: powder coated metal

Cover: Fabric, Rough, Trevira CS+ | CS, Revive 1, Revive 2, Terra, Clara 2, Remix 2, Hero, Tonus 4, Tonus Meadow, Memory 2

 Dry use

 Flat packed

Acoustics



Attenuation



Diffusion

Content

Configurations	3
Fabrics	4
Dimensions	8
Acoustics	9

Configurations

BuzziPlant Doldi

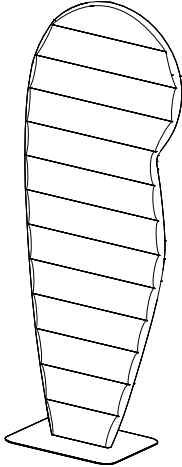

Core: honeycomb cardboard
Filling: foam CME35H + fabric + zipper
Baseplate: powder coated metal

✂ W 68 cm H 179 cm D 2,7 cm
 W 26.77" H 70.47" D 1.06"

⚖ 13 kg
 28.66 lbs

... Color baseplate: Black (RAL 9005) or Alu color (RAL 9006)
 Cover: Fabric, Rough, Trevira CS+ | CS, Revive 1,
 Revive 2, Terra, Clara 2, Remix 2, Hero, Tonus 4,
 Tonus Meadow, Memory 2

BuzziPlant Mobi

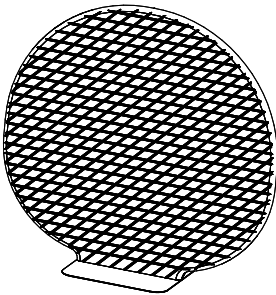

Core: honeycomb cardboard
Filling: foam CME35H + fabric + zipper
Baseplate: powder coated metal

✂ W 127 cm H 120 cm D 2.7 cm
 W 50.00" H 47.24" D 1.06"

⚖ 15,5 kg
 34.17 lbs

... Color baseplate: Black (RAL 9005) or Alu color (RAL 9006)
 Cover: Fabric, Rough, Trevira CS+ | CS, Revive 1,
 Revive 2, Terra, Clara 2, Remix 2, Hero, Tonus 4,
 Tonus Meadow, Memory 2

BuzziPlant Surf

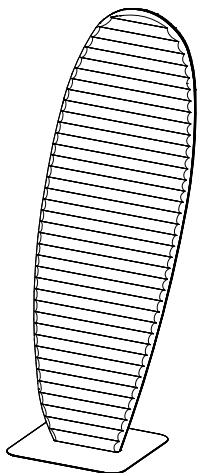

Core: honeycomb cardboard
Filling: foam CME35H + fabric + zipper
Baseplate: powder coated metal

✂ W 64 cm H 178 cm D 2,7 cm
 W 25.20" H 70.08" D 1.06 "

⚖ 12,5 kg
 27.56 lbs

... Color baseplate: Black (RAL 9005) or Alu color (RAL 9006)
 Cover: Fabric, Rough, Trevira CS+ | CS, Revive 1,
 Revive 2, Terra, Clara 2, Remix 2, Hero, Tonus 4,
 Tonus Meadow, Memory 2

Fabrics

Fabric

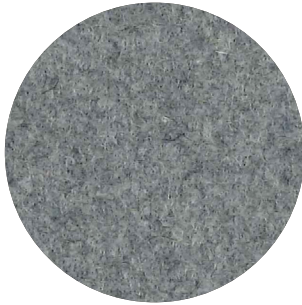

Category A

Composition 70% Recycled Wool, 25% Recycled Polyacryl,
5% Recycled Other Fabrics

Weight 405 g/m² | 11.94 oz/yd²

Abrasion resistance 40.000 Martindale, 50,000 Wyzenbeek

Flammability EU: EN 1021.1/2006 | BS EN 1021.1/2006 (cigarette).
EN 1021.2/2006 | BS EN 1021.2/2006 (match)
USA: CAL TB 117 | ASTM E84 CLASS A

Fastness to light EU: 4 | USA 4

Fastness to rubbing EU: Wet 3-4 | Dry 4-5

Fastness to crocking USA: Wet 5 | Dry 5



Rough



Category A

Composition 100% Polyacryl

Weight 456 g/m² | 13.45 oz/yd²

Abrasion resistance 40.000 Martindale

Flammability EU: EN 1021.1/2006 | BS EN 1021.1/2006 (cigarette)
USA: CAL TB TB 117

Fastness to light EU: 5

Fastness to rubbing EU: Wet: 3 | Dry: 3



Trevira CS+ | CS

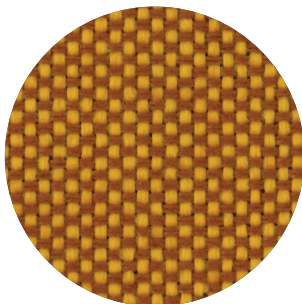

Category A

Weight 420 g/m² | 12.39 oz/yd²

Composition 100% Polyester, Trevira CS

Abrasion resistance 100.000 Martindale, 90,000 Wyzenbeek

Flammability BS 5852 part II: CRIB 5 | BS 7176 Medium Hazard
USA: CAL TB 117 | M1 | B1 | EN 1021/1-2 | C1 |
IMO Res. A652 (16)

Fastness to light EU: 6 | USA 5

Fastness to rubbing EU: Wet 4-5 | Dry 4-5

Fastness to crocking USA: Wet 5 | Dry 5



Revive 1

kvadrat

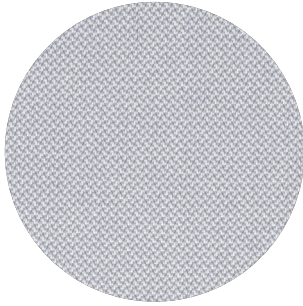

Category A

Composition 100% recycled polyester FR

Weight 430 g/lin.m

Abrasion resistance 60.000 Martindale rubs, EN ISO 12947

Flammability EN 1021-1/2 | DIN 4102 B1 | Önorm B1/Q1
UNI 9175 1IM | US Cal. Tech. Bull. 117
IMO A.652 (16)

Fastness to light Note 5-7, ISO 105-B02

Fastness to rubbing (ISO) dry 5, wet 4-5

Pilling Note 4-5, EN ISO 12945



Revive 2

kvadrat

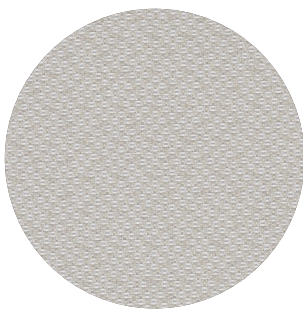

Category A

Composition 100% recycled polyester FR

Weight 420 g/lin.m

Abrasion resistance 45.000 Martindale rubs, EN ISO 12947

Flammability EN 1021-1/2 | DIN 4102 B1 | Önorm B1/Q1
UNI 9175 1IM | US Cal. Tech. Bull. 117
IMO A.652 (16)

Fastness to light Note 5-7, ISO 105-B02

Fastness to rubbing (ISO) dry 5, wet 4-5

Pilling Note 4-5, EN ISO 12945



Terra

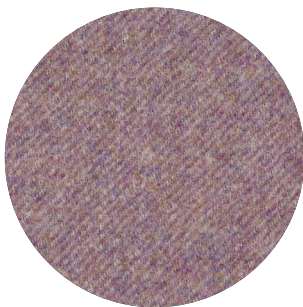

Category B

Composition 100% Pure New Wool

Weight 370 g/m² | 10.91 oz/yd²

Abrasion resistance 40.000 Martindale, 25,000 Wyzenbeek

Flammability EU: BS5852 CRIB 5 | BS5867 PART 2 : 2008 : TYPE B
EN: 1021.2/2006 | USA: CAL TB 117

Fastness to light EU 5 | USA 5

Fastness to rubbing EU: Wet 4 | Dry 4

Fastness to crocking USA: Wet 4 | Dry 4



Clara 2

kvadrat

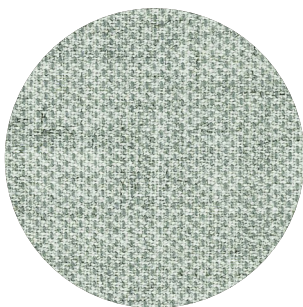

Category B

Composition 92% new wool, 8% nylon

Weight 400 g/lin.m

Abrasion resistance 80.000 Martindale rubs, EN ISO 12947

Flammability EN 1021-1/2 | BS 5852, ignition source 2-3 | DIN 4102 B2
NF D 60 013 | UNI 9175 1IM | US Cal. Tech. Bull. 117, Sec. E
NFPA 260 | IMO A.652(16)

Fastness to light Note 5-7, ISO 105-B02

Fastness to rubbing (ISO) dry 4-5, wet 4

Pilling Note 4, EN ISO 12945



Remix 2

kvadrat



Category B

Composition 90% new wool, 10% nylon

Weight 415 g/lin.m

Abrasion resistance 100.000 Martindale rubs, EN ISO 12947

Flammability EN 1021-1/2 | BS 5852 part 1

Önorm B1/Q1 | NF D 60 013 | UNI 9175, 1IM

AS/NZS 1530.3 | Cal. Tech. Bull. 117-2013

NFPA 260 | IMO FTP Code 2010:Part 8

Fastness to light Note 5-7, ISO 105-B02

Fastness to rubbing (ISO) dry 4-5, wet 4

Pilling Note 4, EN ISO 12945



Hero

kvadrat

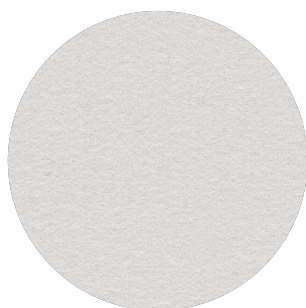

Category C

Composition 96% new wool, 4% nylon

Weight 580 g/lin.m

Abrasion resistance 45.000 Martindale rubs, EN ISO 12947

Flammability EN 1021-1/2 | DIN 4102 B2 | NF D 60 013

UNI 9175 1IM | US Cal. Bull. 117-2013 | NFPA 260

IMO A.652 (16)

Fastness to light Note 5-6, ISO 105-B02

Fastness to rubbing (ISO) dry 4-5, wet 4-5

Pilling Note 3-4, EN ISO 12945



Tonus 4

kvadrat



Category D

Composition 90% new wool, 10% Helanca

Weight 665 g/lin.m

Abrasion resistance 100.000 Martindale rubs, EN ISO 12947

Flammability EN 1021-1/2 | BS 5852 part 1 | DIN 4102 B2

Önorm B1/Q1 | NF D 60 013 | UNI 9175 1IM

US Cal. Bull. 117-2013 | NFPA 260 | IMO A.652 (16)

Fastness to light Note 5-7, ISO 105-B02

Fastness to rubbing (ISO) dry 3-5, wet 3-5

Pilling Note 3, EN ISO 12945



Tonus Meadow

kvadrat

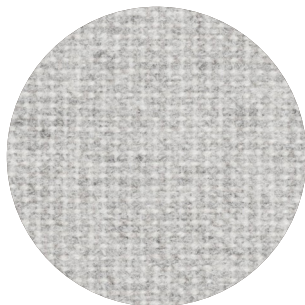

Category D

Composition 90% new wool, 10% Helanca

Weight 665 g/lin.m

Abrasion resistance 100.000 Martindale rubs, EN ISO 12947

Flammability EN 1021-1/2 | BS 5852 part 1 | DIN 4102 B2

Önorm B1/Q1 | NF D 60 013 | UNI 9175 11M

US Cal. Bull. 117-2013 | NFPA 260 | IMO A.652 (16)

Fastness to light Note 5-7, ISO 105-B02

Fastness to rubbing (ISO) dry 4-5, wet 4

Pilling Note 3, EN ISO 12945



Memory 2

kvadrat

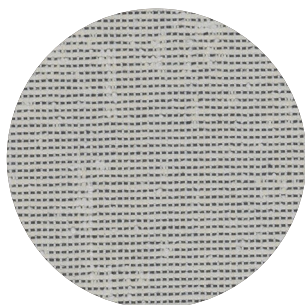

Category E

Composition 100% Trevira CS

Weight 700 g/lin.m

Abrasion resistance

35.000 rubs acc. to the Martindale method, EN ISO 12947

Flammability EN 1021-1/2 | DIN 4102 B1 | Önorm B1/Q1

NF D 60 013 | NF P 92 507 M1 | UNI 9175 11M

UNI 9177 classe 1 | US Cal. Tech. Bull. 117

IMO A.652 (16)

Fastness to light Note 5-8, ISO 105-B02

Fastness to rubbing (ISO) dry 4-5, wet 4-5

Pilling Note 4, EN ISO 12945



Dimensions

BuzziPlant Doldi

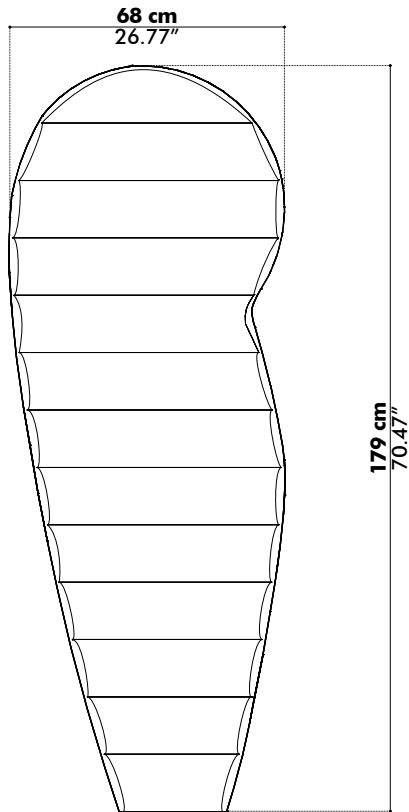

BuzziPlant Surf

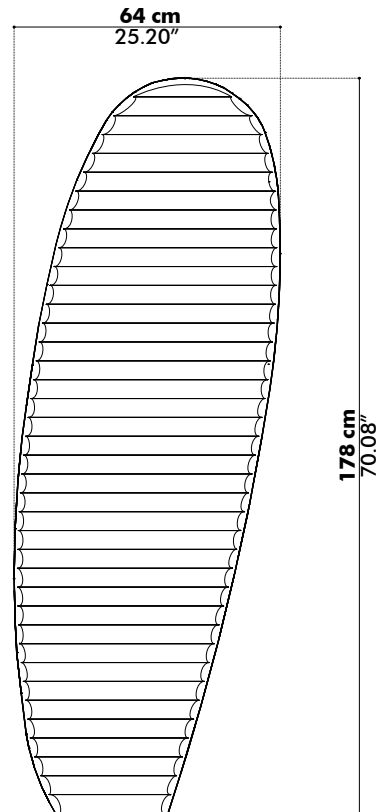

BuzziPlant Mobi

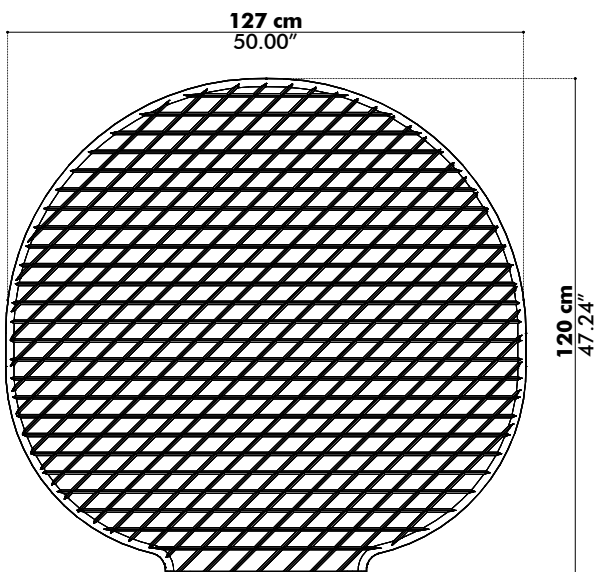

BuzziPlant Baseplate

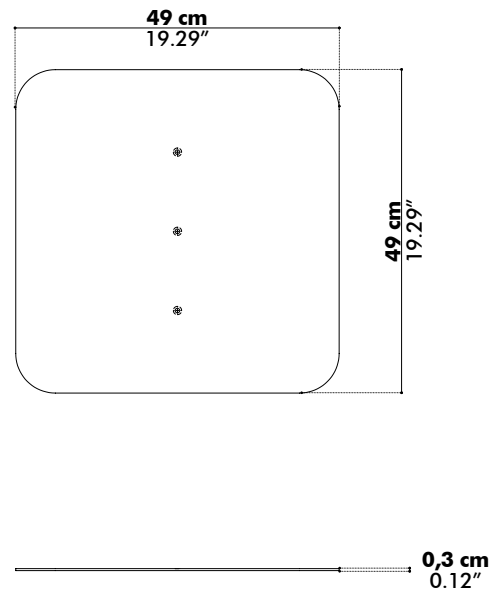

Acoustics

BuzziPlant Doldi | Surf

Equivalent sound absorption area in m² per object

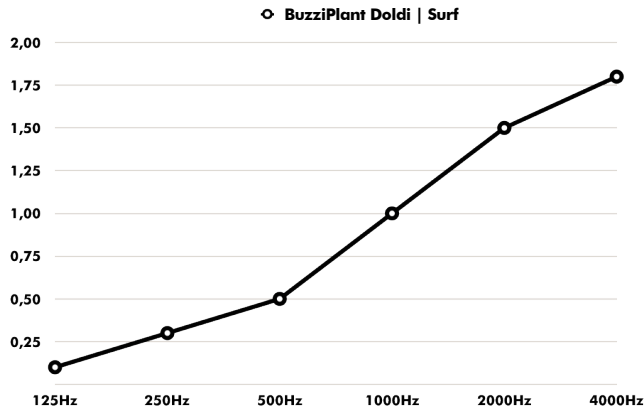

Hz	Aeq/m ²
125	0.10
250	0.30
500	0.50
1000	1.00
2000	1.50
4000	1.80

BuzziPlants Mobi

Equivalent sound absorption area in m² per object

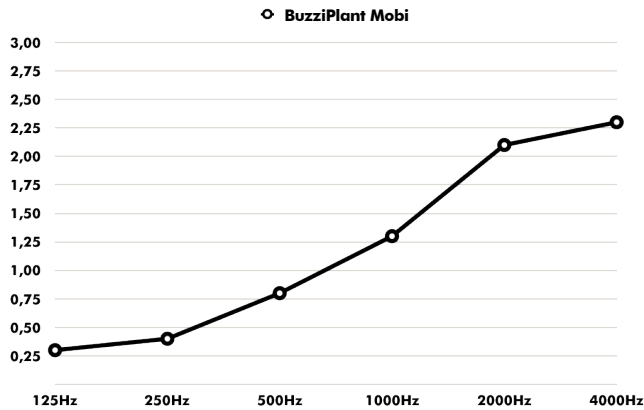

Hz	Aeq/m ²
125	0.30
250	0.40
500	0.80
1000	1.30
2000	2.10
4000	2.30